

**AIR CONDITIONER**  
**REMOTE CONTROLLER ILLUSTRATION**

**RG70C**

The design and specifications are subject to change without prior notice for product improvement. Consult with the sales agency or manufacturer for details.

CR176-RG70C(F)  
16117000000735  
20151230

Thank you very much for purchasing our air conditioner.  
Please read this owner's manual carefully before using  
your air conditioner.

## CONTENTS

Remote controller Specifications.....	1
Operation of buttons .....	2
Indicators on LCD .....	6
How to use the buttons .....	7
AUTO/COOL operation.....	7
DRY/FAN operation.....	8
HEAT operation .....	9
Setting the Timer function .....	9
Handling the remote controller .....	13



### Remote Controller Specifications

Model	RG70C/BGEF, RG70C1/BGEF, RG70F/BGEF
Rated Voltage	3.0V(Dry batteries R03/LR03×2)
Signal Receiving Range	8m
Environment	-5°C~ 60°C

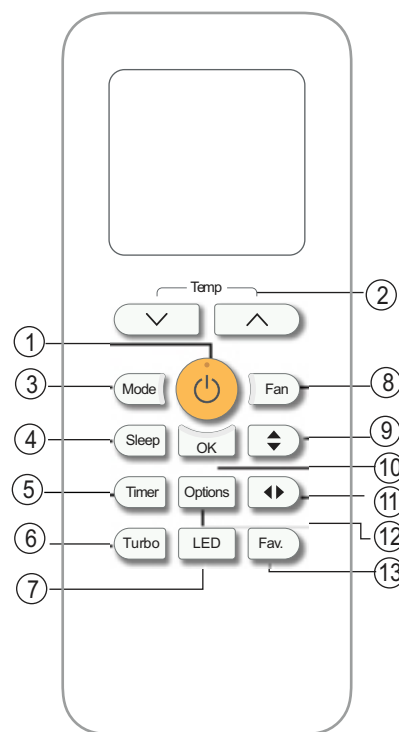
### Operation of buttons



RG70C/BGEF  
RG70C1/BGEF

- ON/OFF Button(  )**  
This button turns the air conditioner ON and OFF.
  - Temp Up Button(  )**  
Press this button to increase the set temperature or Timer setting hours.
- Temp Down Button(  )**  
Push this button to decrease the set temperature or Timer setting hours.

#### NOTE:

- When the air conditioner operates under heating mode with the set temperature of 17°C, pressing  button continuously for two times will activate 8 Degree heating. The indoor unit display shows 'FP'.

- Mode Button**  
Press this button to modify the air conditioner mode in a sequence of following:

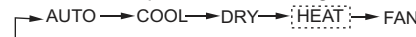

**NOTE:** Please do not select HEAT mode if the machine you purchased is cooling only type. Heat mode is not supported by the cooling only appliance.

- Sleep button(applicable to RG70C(1)/BGEF)**

Used to active/cancel Sleep mode. It can maintain the most comfortable temperature and save energy. This function is available on COOL, HEAT or AUTO mode only .

For the detail, see "sleep operation" in "USER'S MANUAL"

- ECO Button(applicable to RG70F/BGEF)**

Used to enter the energy efficient mode. Under cooling mode, press this button, the remote controller will adjust the temperature automatically to 24°C, fan speed of Auto to save energy (but only if the set temperature is less than 24°C). If the set temperature is between 24°C and 30°C, press the ECO button, the fan speed will change to Auto, the set temperature will remain unchanged.

## Operation of buttons

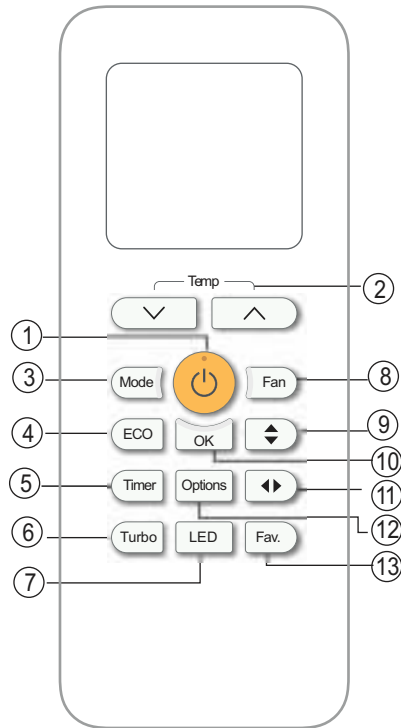

RG70F/BGEF

- NOTE:**
- Pressing the **ON/OFF** button, or modifying the mode or adjusting the set temperature to less than 24°C will stop ECO operation.
  - Under ECO operation, the set temperature should be 24°C or more. It may result in insufficient cooling. If you feel uncomfortable, just press the ECO button again to stop it.

- 5 Timer Button**  
Press this button to initiate the auto-on/ auto-off time sequence.
- 6 Turbo Button**  
The TURBO function makes the unit work extra hard to reach your present temperature in the shortest amount of time possible.
- When you press the **TURBO** button in COOL mode, the unit will blow cool air with strongest wind setting to jump-start the cooling process.
  - When you press the **TURBO** button in HEAT mode, for units with Electric heat elements, the Electric Heater will activate and jump-start the heating process.

- 7 LED Button**  
If you are sensitive to light when you go to sleep, you can press the LED button to turn off the LED display on the indoor unit. Press the button again to turn it back on.

- 8 Fan Button**  
Used to select the fan speed in four steps:  
 → AUTO → LOW → MED → HIGH →

- NOTE:**
- You can not switch the fan speed in AUTO or DRY mode.
  - Hold down this button for at least 2 seconds to activate/cancel **Silent** mode. Due to low frequency operation of compressor, it may result in insufficient cooling and heating capacity (applicable to the air conditioner with Silent feature only)
  - Press Fan, MODE, Sleep, ON/OFF, ECO or Turbo button will cancel the Silent function.

## Operation of buttons

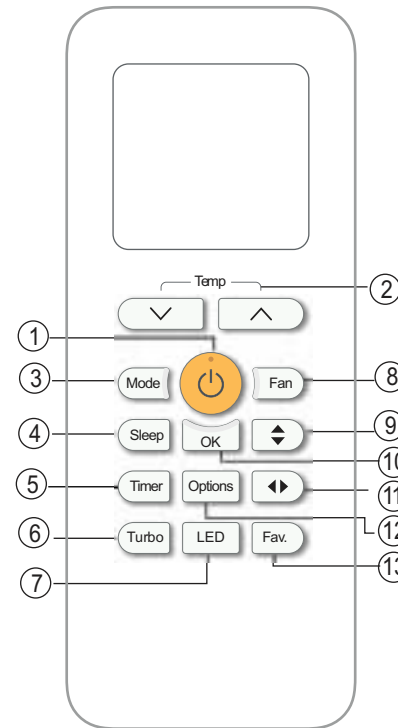

RG70C/BGEF  
RG70C1/BGEF

- 9 Swing ↕ Button**  
Used to stop or start horizontal louver movement or set the desired up/down air flow direction. The louver changes 6 degree in angle for each press. If keep pushing more than 2 seconds, the louver will swing up and down automatically.
- 10 OK Button**  
Used to confirm the optional functions.
- 11 Swing ⇄ Button**  
Used to stop or start vertical louver movement and set the desired left/right air flow direction. The louver changes 6 degree in angle for each press. If keep pushing more than 2 seconds, the louver will swing left and right automatically.

- 12 Options Button**  
Press this button to select the air conditioner function in a sequence of following:  
 → Fresh → Follow me → Comfort → Self clean →

Press the Options button to select the desired function, the selected symbol will flash on the display area, then press the OK button to confirm.

- \* FRESH function (🌿)**  
When the FRESH function is initiated, the Ionizer/Plasma Dust Collector (depending on models) is energized and will help to remove pollen and impurities from the air.

- \* FOLLOW ME function (👤)**  
When the FollowMe function is activated, the remote displays actual temperature at its location. The remote control will send this signal to the air conditioner every 3 minutes interval until press the FOLLOW ME button again.

- \* Comfort function (🌡️)**  
When the Comfort function is activated, the air conditioner will be set at 23 °C automatically. It is not available under fan mode.

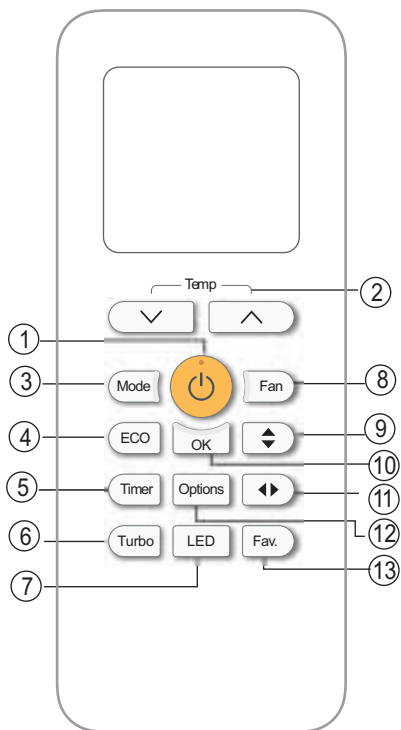

RG70F/BGEF

**\* SELF CLEAN function( )**

Under SELF CLEANmode, the air conditioner will automatically clean and dry the Evaporator and keep it as fresh for the next operation. It is not available under heating or fan mode.

(\* Indicate optional functions)

**Fav.Button**

- Used to restore the current settings or resume previous settings.
- On the first time connecting to the power, if push the **Fav.** button, the unit will operate on AUTO mode, 26°C, and fan speed is Auto.
- Push this button when remote controller is on, the system will automatically revert back to the previous settings including operating mode, setting temperature, fan speed level and sleep feature(if activated).
- If pushing more than 2 seconds, the system will automatically restore the current operation settings including operating mode, setting temperature, fan speed level and sleep feature(if activated).

**NOTE:**

- Buttons design is based on typical model and might be slightly different from the actual one you purchased, the actual shape shall prevail.
- All the functions described are accomplished by the unit. If the unit has no this feature, there is no corresponding operation happened when press the relative button on the remote controller.
- When there are wide differences between "Remote controller Illustration" and "USER'S MANUAL" on function description, the description of "USER'S MANUAL" shall prevail.

**Indicators on LCD**

Information are displayed when the remote controller is powered up.

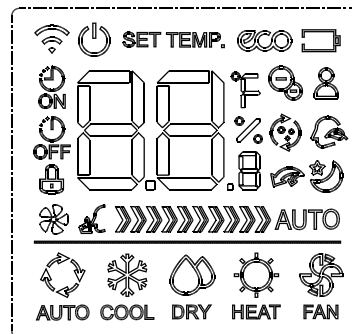

**Mode display**

AUTO	COOL	DRY	HEAT	FAN
	Displayed when data transmitted.			
	Displayed when remote controller is ON.			
	Displayed in ECO mode operation			
	Battery display (low battery detection)			
	Displayed when TIMER ON time is set.			
	Displayed when TIMER OFF time is set.			
	Not available for this unit.			
	Displayed when Silent feature is activated			
	Show set temperature or room temperature, or time under TIMER setting.			
	Indicated that the air conditioner is operating in Follow me mode			
	Displayed when select Fresh feature			
	Displayed when select Self clean feature			
	Displayed when select Comfort feature			
	Displayed in Sleep Mode operation.			
	Not available for this unit.			

**Fan speed indication**

		Low speed
		Medium speed
		High speed
		AUTO Auto fan speed

**Note:**

All indicators shown in the figure are for the purpose of clear presentation. But during the actual operation only the relative functional signs are shown on the display window.

### How to use the buttons

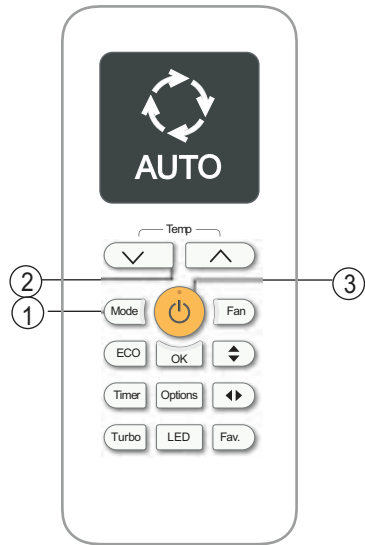

#### AUTO operation

##### SETTING TEMPERATURE

The operating temperature range for units is 17-30°C. You can increase or decrease the set temperature in 1°C increments.

In **AUTO** mode, the unit will automatically select the COOL, FAN, HEAT or DRY mode based on the set temperature.

1. Press the **MODE** button to select Auto mode.
2. Set your desired temperature using the **Temp** ∨ or **Temp** ∧ button.
3. Press the **ON/OFF** button to start the unit.

**NOTE:** FAN SPEED can't be set in Auto mode.

#### COOL operation

1. Press the **MODE** button to select **COOL** mode.
2. Set your desired temperature using the **Temp** ∨ or **Temp** ∧ button.
3. Press the **FAN** button to select the fan speed: AUTO, LOW, MED, or HIGH.
4. Press the **ON/OFF** button to start the unit.

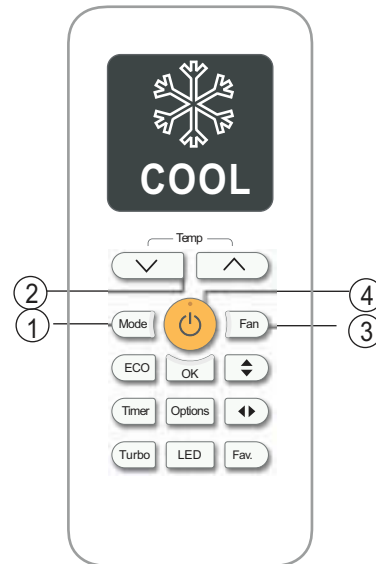

### How to use the buttons

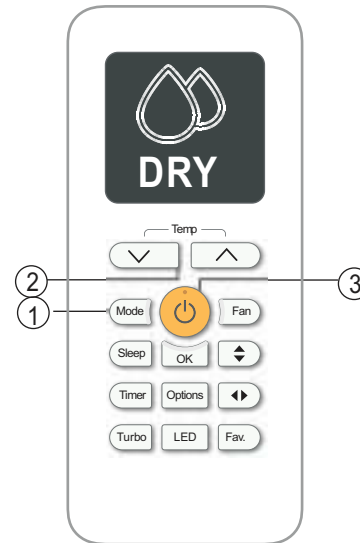

#### DRY operation(dehumidifying)

1. Press the **MODE** button to select **DRY** mode.
2. Set your desired temperature using the **Temp** ∨ or **Temp** ∧ button.
3. Press the **ON/OFF** button to start the unit.

**NOTE:** FAN SPEED can't be changed in DRY mode.

#### FAN operation

1. Press the **MODE** button to select **FAN** mode.
2. Press **FAN** button to select the fan speed: AUTO, LOW, MED or HIGH.
3. Press the **ON/OFF** button to start the unit.

**NOTE:** You can't set temperature in FAN mode. As a result, your remote control & LCD screen will not display temperature.

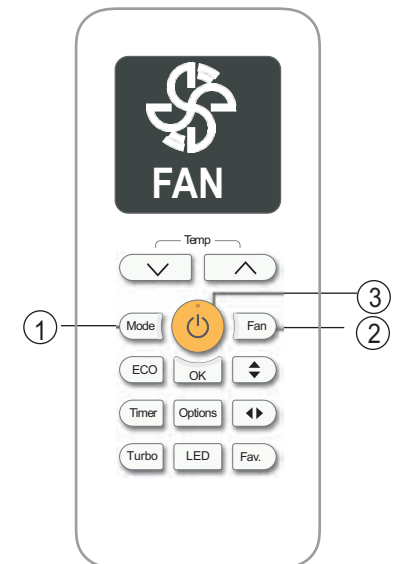

## How to use the buttons

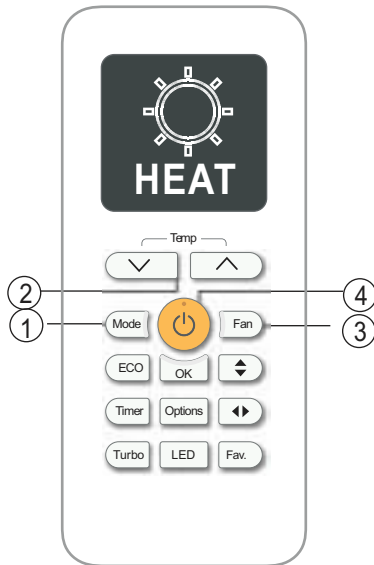

### HEAT operation

1. Press the **MODE** button to select **HEAT** mode.
2. Set your desired temperature using the **Temp**  $\nabla$  or **Temp**  $\wedge$  button.
3. Press the **FAN** button to select the fan speed: AUTO, LOW, MED, or HIGH.
4. Press the **ON/OFF** button to start the unit.

**NOTE:** As outdoor temperature drops, the performance of your unit's HEAT function may be affected. In such instances, we recommend using this air conditioner in conjunction with other heating appliance.

### Setting the TIMER function

Your air conditioning unit has two timer-related functions:

- **TIMER ON**- sets the amount of timer after which the unit will automatically turn on.
- **TIMER OFF**- sets the amount of time after which the unit will automatically turn off.

#### TIMER ON function

The **TIMER ON** function allows you to set a period of time after which the unit will automatically turn on, such as when you come home from work.

1. Press the **Timer** button, the Timer on indicator "ON" displays and flashes. By default, the last time period that you set and an "h" (indicating hours) will appear on the display.

**Note:** This number indicates the amount of time after the current time that you want the unit to turn on. For example, if you set **TIMER ON** for 2 hours, "2.0h" will appear on the screen, and the unit will turn on after 2 hours.

2. Press the **Temp**  $\nabla$  or  $\wedge$  button to set the time when you want the unit to turn on.
3. Wait 2 seconds, then the **TIMER ON** function will be activated. The digital display on your remote control will then return to the temperature display.

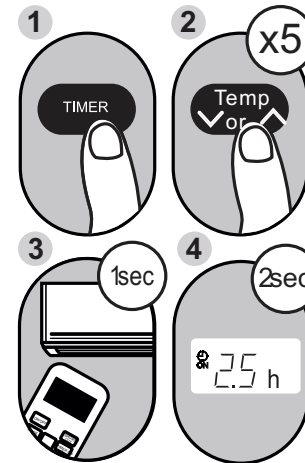

**Example:** Setting unit to turn on after 2.5 hours.

#### TIMER OFF function

The **TIMER OFF** function allows you to set a period of time after which the unit will automatically turn off, such as when you wake up.

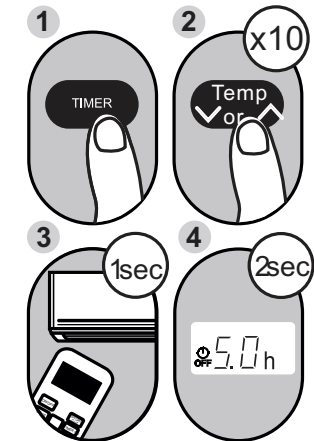

**Example:** Setting unit to turn off after 5 hours.

**NOTE:** When setting the **TIMER ON** or **TIMER OFF** functions, up to 10 hours, the time will increase in 30 minute increments with each press. After 10 hours and up to 24, it will increase in 1 hour increments. The timer will revert to zero after 24 hours. You can turn off either function by setting its timer to "0.0h".

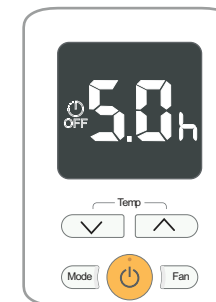

Continue to press **Temp**  $\nabla$  or  $\wedge$  button until desired time is reached.

**Setting both TIMERON and TIMEROFF at the same time**

Keep in mind that the time periods you set for both functions refer to hours after the current time. For example, say that the current time is 1:00 PM, and you want the unit to turn on automatically at 7:00 PM. You want it to operate for 2 hours, then automatically turn off at 9:00 PM.

Do the following:

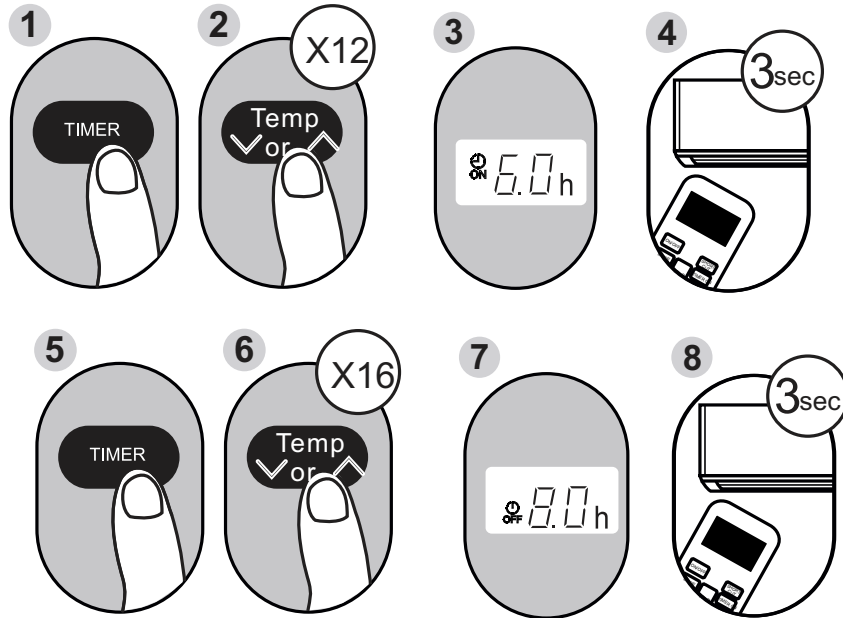

**Example:** Setting the unit to turn on after 6 hours, operate for 2 hours, then turn off (see the figure below)

**Your remote display**

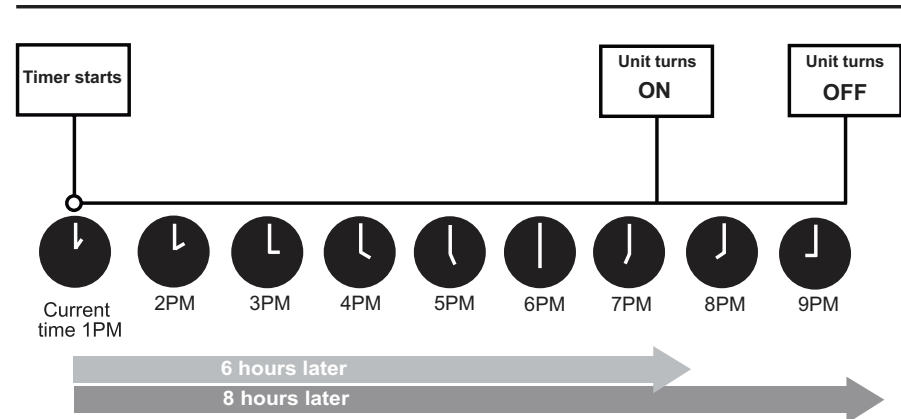
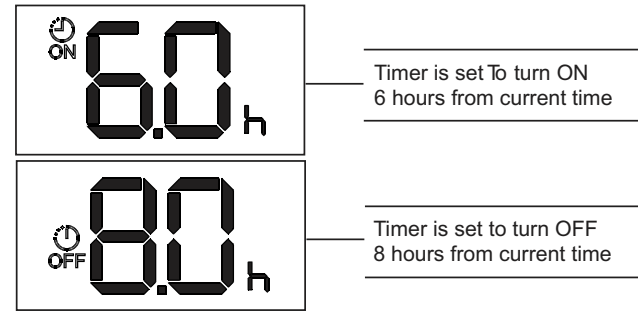

## Handling the remote controller

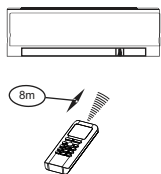

### Location of the remote controller.

- Use the remote controller within a distance of 8 meters from the appliance, pointing it towards the receiver. Reception is confirmed by a beep.

### ⚠ CAUTIONS

- The air conditioner will not operate if curtains, doors or other materials block the signals from the remote controller to the indoor unit.
- Prevent any liquid from falling into the remote controller. Do not expose the remote controller to direct sunlight or heat.
- If the infrared signal receiver on the indoor unit is exposed to direct sunlight, the air conditioner may not function properly. Use curtains to prevent the sunlight from falling on the receiver.
- If other electrical appliances react to the remote controller, either move these appliances or consult your local dealer.
- Do not drop the remote controller. Handle with care.
- Do not place heavy objects on the remote controller, or step on it.

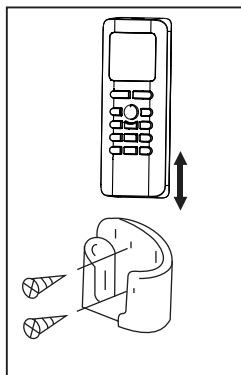

### Using the remote controller holder (optional)

- The remote controller can be attached to a wall or pillar by using a remote controller holder(not supplied, purchased separately).
- Before installing the remote controller, check that the air conditioner receives the signals properly.
- Install the remote controller with two screws.
- For installing or removing the remote controller, move it up or down in the holder.

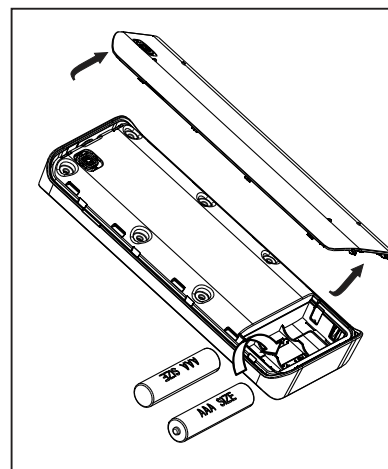

### Replacing batteries

The following cases signify exhausted batteries. Replace old batteries with new ones.

- Receiving beep is not emitted when a signal is transmitted.
- Indicator fades away.

The remote controller is powered by two dry batteries (R03/LR03X2) housed in the back rear part and protected by a cover.

- (1) Remove the back cover of the remote controller.
- (2) Remove the old batteries and insert the new batteries, placing the (+) and (-) ends correctly.
- (3) Install the cover back on.

**NOTE:** When the batteries are removed, the remote controller erases all programming. After inserting new batteries, the remote controller must be reprogrammed.

### ⚠ CAUTIONS

- Do not mix old and new batteries or batteries of different types.
- Do not leave the batteries in the remote controller if they are not going to be used for 2 or 3 months.
- Do not dispose batteries as unsorted municipal waste. Collection of such waste separately for special treatment is necessary.